

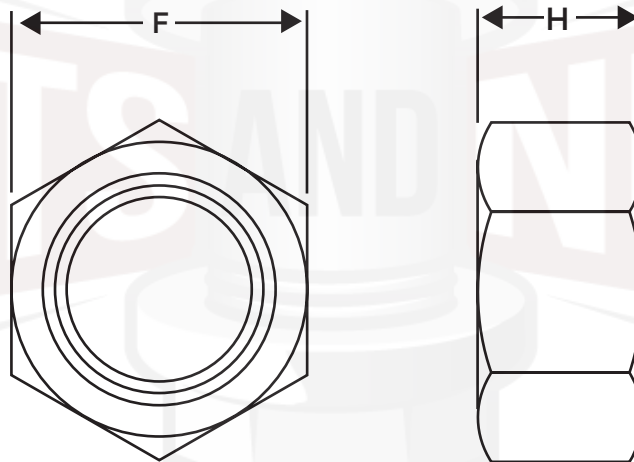

## Grade 5 Hex Nuts



Nominal Size or Basic Bolt Diameter	F		H	
	Width Across Flats (IN)		Nut Thickness (IN)	
	Max	Min	Max	Min
1/4"	0.438	0.428	0.226	0.212
5/16"	0.500	0.489	0.273	0.258
3/8"	0.562	0.551	0.337	0.320
7/16"	0.688	0.675	0.385	0.365
1/2"	0.750	0.736	0.448	0.427
9/16"	0.875	0.861	0.496	0.473
5/8"	0.938	0.922	0.559	0.535
3/4"	1.125	1.088	0.665	0.617
7/8"	1.312	1.269	0.776	0.724
1"	1.500	1.45	0.887	0.831

**Dimensions: ASME B18.2.2**  
**Material: SAE J995 Grade 5**  
**Threading: ASME B1.1, UNC & UNF, Class 2B**

440.606.6557

www.boltsandnuts.com

info@boltsandnuts.com

ONLINE FASTENER GROUP LLC CLAIMS ALL PROPRIETARY RIGHTS TO THIS DRAWING AND THE INFORMATION IT CONTAINS. THIS MATERIAL IS CONFIDENTIAL. DISCLOSURE, REPRODUCTION, AND MANUFACTURING IS STRICTLY PROHIBITED WITHOUT THE EXPRESS WRITTEN PERMISSION OF ONLINE FASTENER GROUP LLC. ALL RIGHTS OF DESIGN OR INVENTION ARE RESERVED.