

Class 8 Hex Flange Nylon Insert Lock Nuts

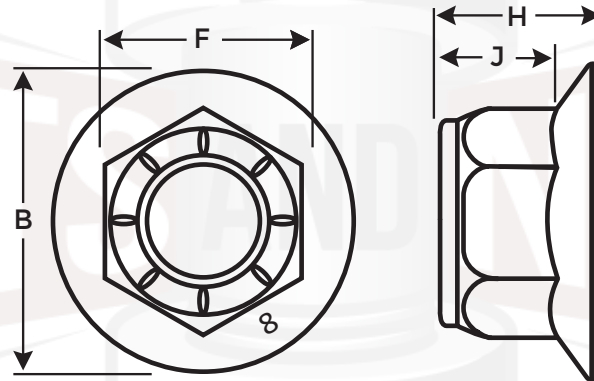

Inches						
Nominal Size or Basic Bolt Diameter	F		B	H		J
	Width Across Flats		Flange Dia	Nut Thickness		Wrench Height
	Max	Min	Max	Max	Min	Min
M5	8.00	7.78	11.80	7.10	6.74	4.70
M6	10.00	9.78	14.20	9.10	8.74	5.70
M8	13.00	12.73	17.90	11.10	10.67	7.60
M10	15.00	14.73	21.80	13.50	13.07	9.60
M12	18.00	17.73	26.00	16.10	15.67	11.60
M14	21.00	20.67	29.90	18.20	17.68	13.30
M16	24.00	23.67	34.50	20.30	19.46	15.30

Dimensions: DIN 6926 Nylon Insert Lock Nut
Material: ISO 898-2 Class 8

440.606.6557

www.boltsandnuts.com

info@boltsandnuts.com

ONLINE FASTENER GROUP LLC CLAIMS ALL PROPRIETARY RIGHTS TO THIS DRAWING AND THE INFORMATION IT CONTAINS. THIS MATERIAL IS CONFIDENTIAL. DISCLOSURE, REPRODUCTION, AND MANUFACTURING IS STRICTLY PROHIBITED WITHOUT THE EXPRESS WRITTEN PERMISSION OF ONLINE FASTENER GROUP LLC . ALL RIGHTS OF DESIGN OR INVENTION ARE RESERVED.